



# SUBMITTAL/TECHNICAL DATA SHEET

www.AccessDoorsAndPanels.com

## APPLICATION

For drywall, walls and ceilings with galvanized steel drywall taping bead flange. For when temperature rise or heat transmission is a factor.

## FEATURES

- Insulated door panel
- Concealed hinge
- Self-closing
- Self-Latching
- Inside latch release
- Drywall taping bead flange

## SPECIFICATIONS

**MATERIAL:** Steel or Stainless Steel

**DOOR:** 20 gauge, filled with 2" thick fire rated insulation,

**MOUNTING FRAME:** 16 gauge, flange to be drywall taping bead flange

**HINGE:** Concealed

**FIRE RATING:** (Walls): UL – 1-1/2 hour "B" label. ULC – 2 hour "B" label. Max size: 36 x 48. (Ceilings):

Warnock Hersey International 3 hour rated in a non-combustible ceiling. 1 hour rated in a combustibile ceiling. Max size: 24 x 36

**STANDARD LATCH:** Universal self-latching bolt, operated by either a knurled knob or flush key. Doors can be prepared for mortise cylinder locks (Master Keying).

**FINISH:** Steel: 5 stage iron phosphate preparation with prime coat of white baked-on enamel. Stainless Steel: #4 satin polish

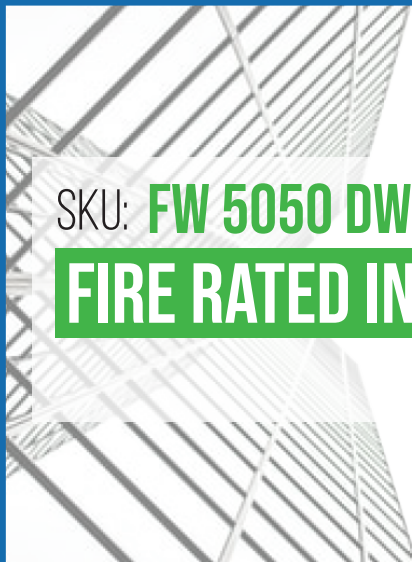

SKU: **FW 5050 DW**

**FIRE RATED INSULATED**

FOR DRYWALL



## DIMENSIONS AND APPEARANCE

>> CLICK TO VIEW ADDITIONAL DETAILS AND PRICING <<

### STANDARD SIZES:

DOOR SIZE W x H INCHES (MM)	LATCHES	WEIGHT	
		LBS	KG
8 x 8 (203 x 203)	1	8	3.6
10 x 10 (254 x 254)	1	9	4.1
12 x 12 (305 x 305)	1	10	4.8
14 x 14 (356 x 356)	1	12	5.4
16 x 16 (406 x 406)	1	15	6.8
18 x 18 (457 x 457)	1	20	9.1
22 x 30 (559 x 762)	2	32.5	14.5
22 x 36 (559 x 914)	2	35	15.9
24 x 24 (610 x 610)	1	28	12.7
24 x 36 (610 x 914)	2	38	18.1
*24 x 48 (610 x 1219)	2	48	21.3
*30 x 30 (762 x 762)	2	38	18.1
36 x 36 (914 x 914)	2	54	24.5
*36 x 48 (914 x 1220)	2	76	34.4

\* Non-Rated for Ceilings

Wall opening is W + 3/8" (9 mm)

For detailed specifications see submittal sheet

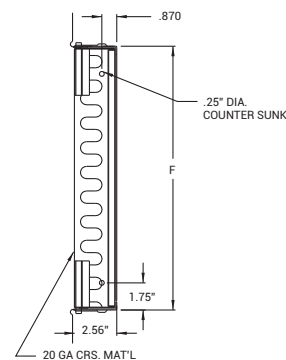
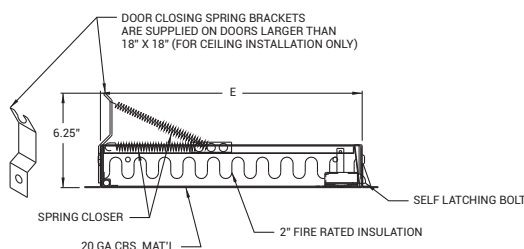

FOR WALLS THIS DOOR HAS A "UL" AND "ULC", 1 1/2 HOUR "B" LABEL, WITH A MAXIMUM TEMPERATURE OF 250 DEGREES AFTER 30 MINUTES.

FOR FIRE RATED CEILINGS, THIS DOOR HAS BEEN APPROVED BY WARNOCK HERSEY INTERNATIONAL FOR 3 HOURS (MAX. SIZE 24' x 36').

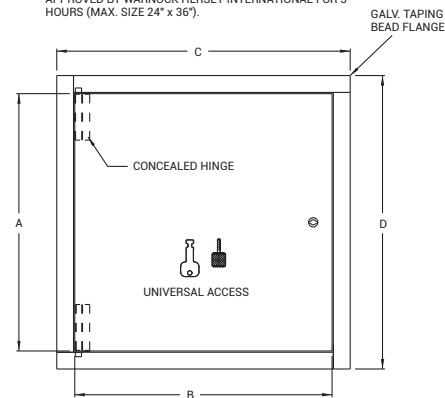

Proprietary property of Acudor Products, Inc., sold and distributed with proper authorization

For a complete list of options visit [www.AccessDoorsAndPanels.com](http://www.AccessDoorsAndPanels.com)

## PROJECT DATA

Custom Sizes Available - Fast!

PROJECT NAME :	QTY	W	H	OPTIONS
ARCHITECT :				
DEALER :				
CONTRACTOR :				
LOCATION :	SPECIAL INSTRUCTIONS :			
DATE :				
TAGGING INSTRUCTIONS :	SUBMITTAL APPROVAL : (signature or stamp)			

Scan or Click



To view Pricing and Additional Product Info.

TELEPHONE:  
1-888-457-1275  
FAX:  
1-888-626-2907

PO BOX 66738 #76520,  
SAINT LOUIS, MO  
63166-6738  
USA



WEBSITE:  
[www.AccessDoorsAndPanels.com](http://www.AccessDoorsAndPanels.com)

E-MAIL:  
[info@AccessDoorsAndPanels.com](mailto:info@AccessDoorsAndPanels.com)



# FW 5050 DW

# FIRE RATED DOOR

NOMINAL DOOR SIZE	A	B	C	D	E	F	LOCK
Inches (mm)							
8 x 8 (203 x 203)	7.78 (198)	7.78 (198)	10.62 (270)	10.62 (270)	8.12 (206)	8.12 (206)	1
10 x 10 (254 x 254)	9.78 (248)	9.78 (248)	12.62 (321)	12.62 (321)	10.12 (257)	10.12 (257)	1
12 x 12 (305 x 305)	11.78 (299)	11.78 (299)	14.62 (371)	14.62 (371)	12.12 (308)	12.12 (308)	1
14 x 14 (456 x 456)	13.78 (350)	13.78 (350)	16.62 (422)	16.62 (422)	14.12 (359)	14.12 (359)	1
16 x 16 (406 x 406)	15.78 (401)	15.78 (401)	18.62 (473)	18.62 (473)	16.12 (409)	16.12 (409)	1
18 x 18 (457 x 457)	17.78 (452)	17.78 (452)	20.62 (524)	20.62 (524)	18.12 (460)	18.12 (460)	1
24 x 24 (610 x 610)	23.78 (604)	23.78 (604)	26.62 (676)	26.62 (676)	24.12 (613)	24.12 (613)	1

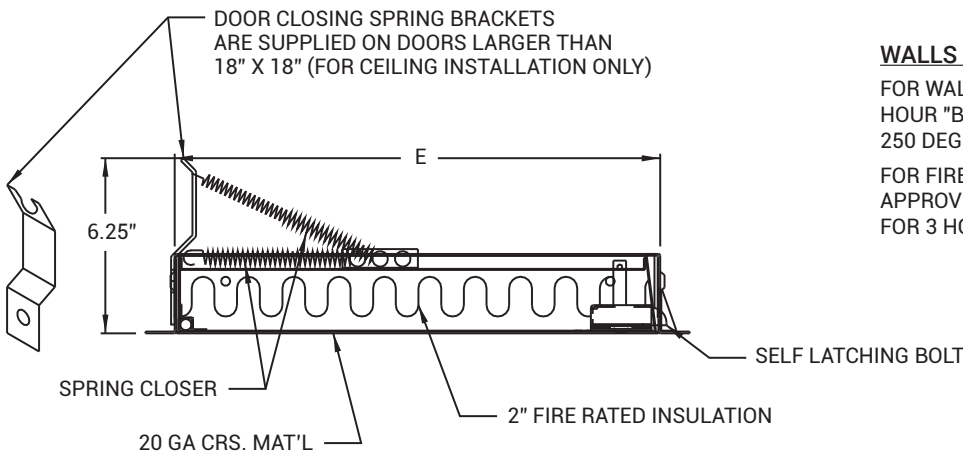

### WALLS AND CEILINGS

FOR WALLS THIS DOOR HAS A "UL" AND "ULC", 1 1/2 HOUR "B" LABEL, WITH A MAXIMUM TEMPERATURE OF 250 DEGREES AFTER 30 MINUTES.

FOR FIRE RATED CEILINGS, THIS DOOR HAS BEEN APPROVED BY WARNOCK HERSEY INTERNATIONAL FOR 3 HOURS (MAX. SIZE 24" x 36")

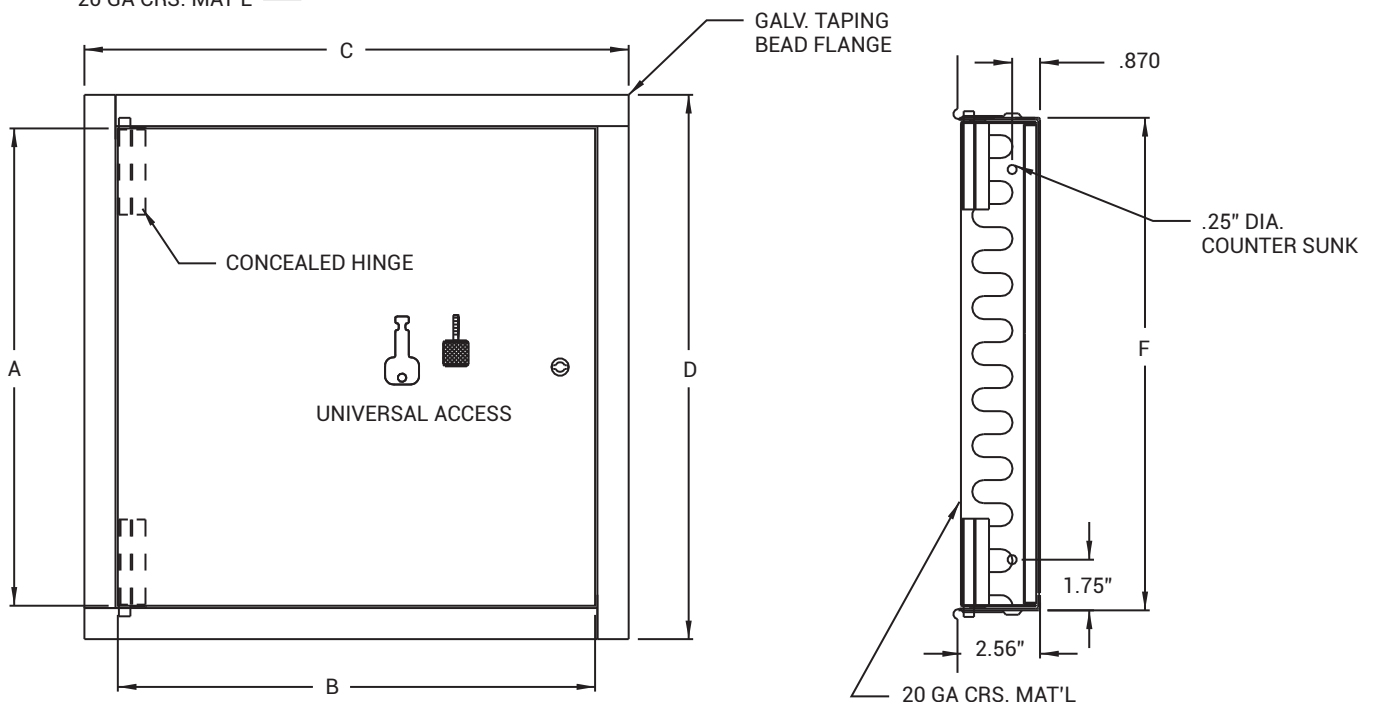



# FW 5050 DW

# FIRE RATED DOOR

NOMINAL DOOR SIZE	A	B	C	D	E	F	LOCK
Inches (mm)							
22 x 30 (559 x 762)	29.78 (756)	21.78 (553)	24.62 (625)	32.62 (829)	22.12 (562)	30.12 (765)	2
22 x 36 (559 x 914)	35.78 (909)	21.78 (553)	24.62 (625)	38.62 (981)	22.12 (562)	36.12 (917)	2
24 x 36 (610 x 914)	35.78 (909)	23.78 (604)	26.62 (676)	38.62 (981)	24.12 (613)	36.12 (917)	2
24 x 48 (610 x 1219)	47.78 (1214)	23.78 (604)	26.62 (676)	50.62 (1286)	24.12 (613)	48.12 (1222)	2
30 x 30 (762 x 762)	29.78 (756)	29.78 (756)	32.62 (829)	32.62 (829)	30.12 (765)	30.12 (765)	2
36 x 36 (914 x 914)	35.78 (909)	35.78 (909)	38.62 (981)	38.62 (981)	36.12 (917)	36.12 (917)	2
36 x 48 (914 x 1220)	47.78 (1214)	35.78 (909)	38.62 (981)	50.62 (1286)	36.12 (917)	48.12 (1222)	2

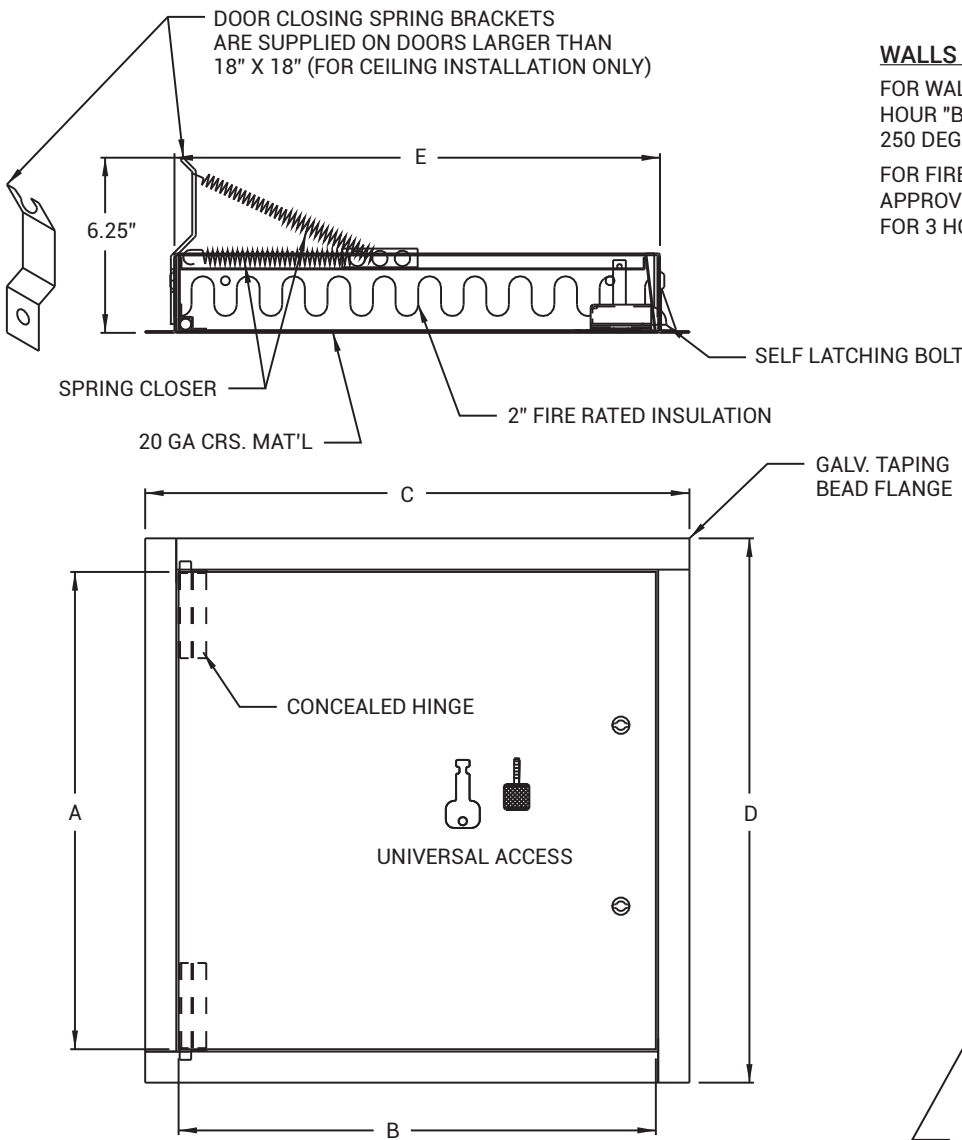

### WALLS AND CEILINGS

FOR WALLS THIS DOOR HAS A "UL" AND "ULC", 1 1/2 HOUR "B" LABEL, WITH A MAXIMUM TEMPERATURE OF 250 DEGREES AFTER 30 MINUTES.

FOR FIRE RATED CEILINGS, THIS DOOR HAS BEEN APPROVED BY WARNOCK HERSEY INTERNATIONAL FOR 3 HOURS (MAX. SIZE 24" x 36")

